

## Fiberoptic Rapid Prototyping

### Tailored FBG Arrays for FiSpec Interrogators at 850nm

Up to 30 FBG at arbitrary Positions

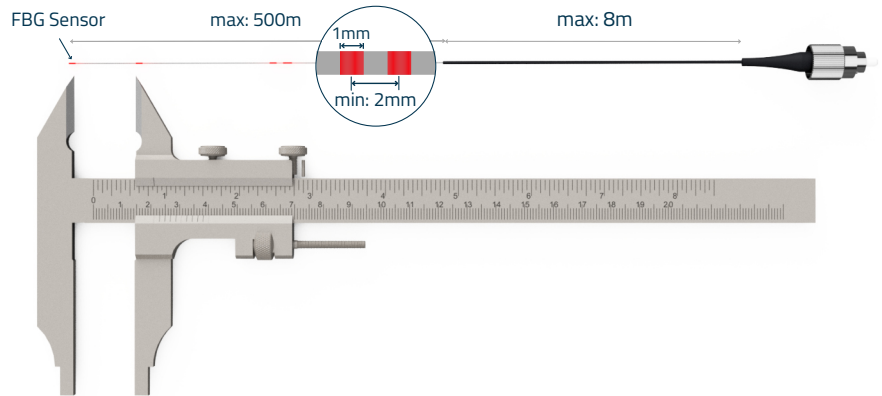

### Off-the-shelf Packaging Options

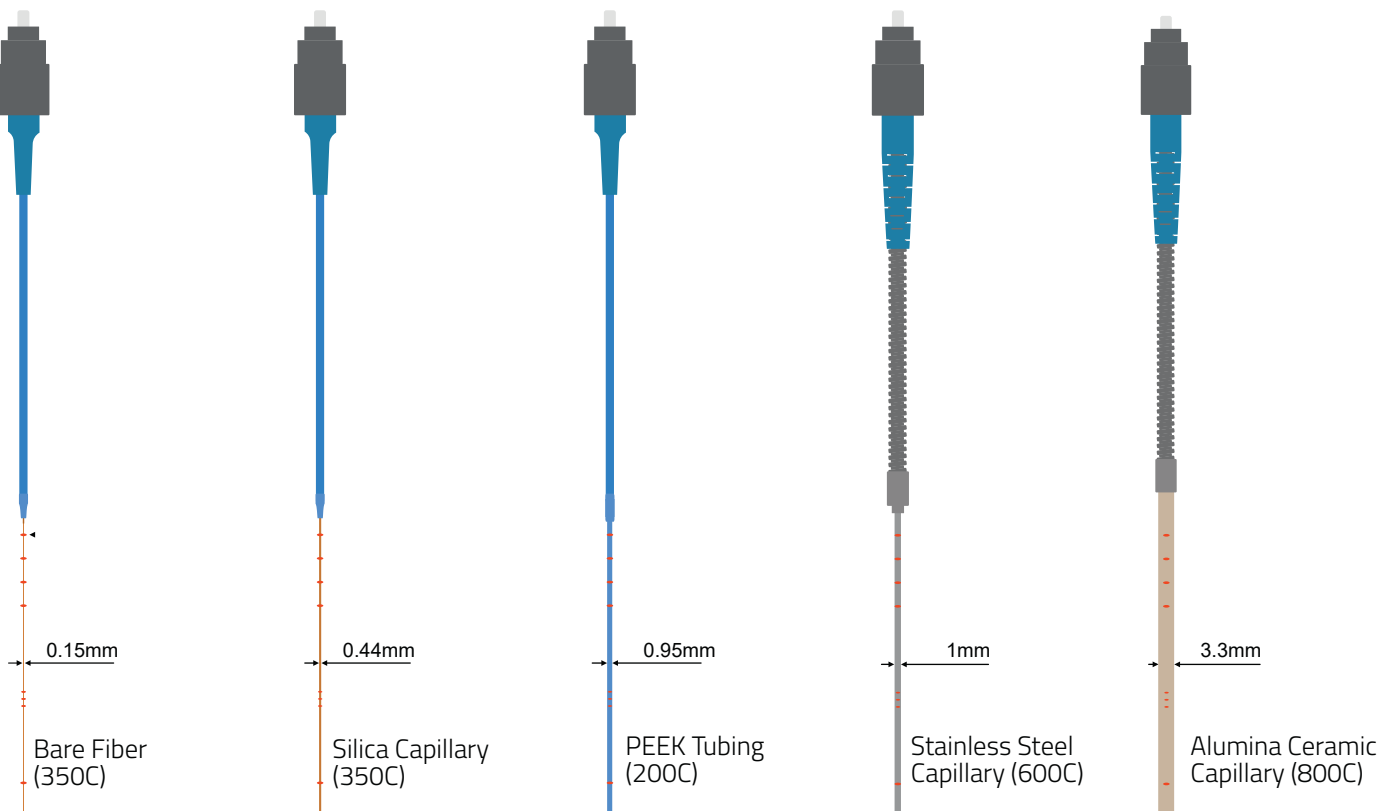

# A) FBG Array Part Number

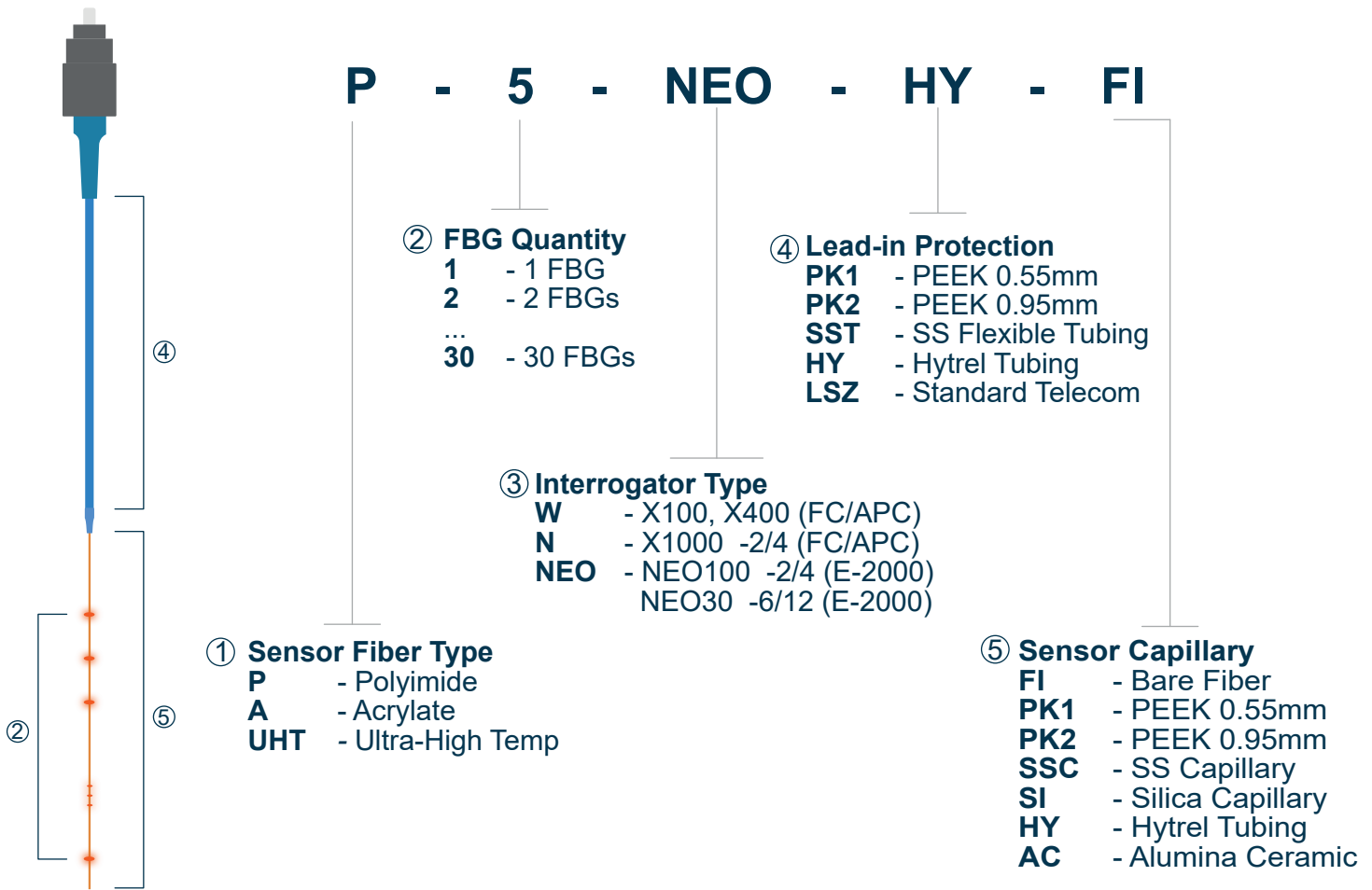

## ① Sensor Fiber Type (Optimization for Application)

	Fiber	Application	Operating Temperature	Capillary Options (5)
<b>P</b>	Polyimide Coating	Strain, Temperature	-250...+300C	FI, PK, SSC, SI, HY
<b>A</b>	Acrylate Coating	Strain, Temperature	-40...+80C	FI, HY, PK
<b>UHT</b>	No Coating	Temperature	-250...+800C	SSC, SI, AC

## ③ Interrogator Type (Optimization for Connector and FBG Center Wavelengths)

**X100 & X400**



**X1000**

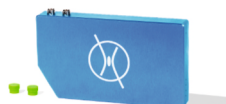

**NEO100-2 and -4  
NEO30-6 and -12**



**FC/APC Connector**



**Wide Spectral Range**

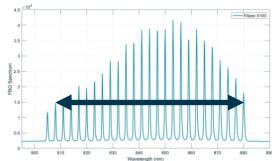

808-880nm

**FC/APC Connector**



**Narrow Spectral Range**

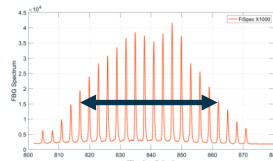

815-865nm

**E-2000 APC Connector**



**Wide Spectral Range**

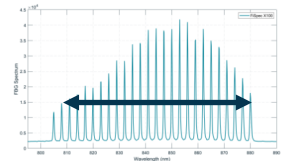

808-880nm

**④ Lead-In Protection**

**SST - Stainless Steel (1.4301) Corrugated Tube**

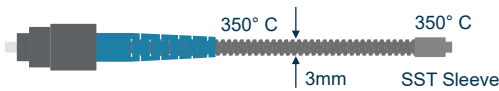

**LSZ - Low Smoke Zero Halogen**

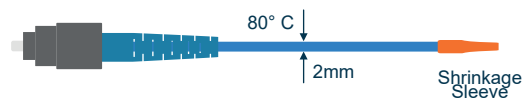

**PK1/2 - PEEK Tubing**



**HY - Hytrel Buffer**

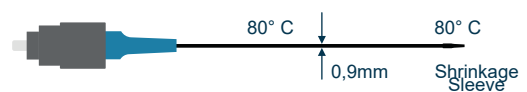

**⑤ Sensor Capillary**

**FI - Bare Fiber with Polyimide Coating**

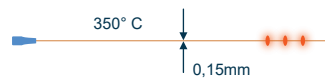

**SSC - Stainless Steel (1.4301) Capillary**

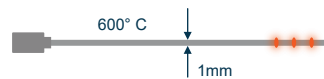

**AC - Alumina Ceramic**

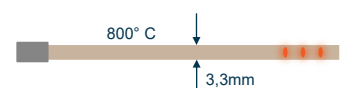

**SI - Silica Capillary**

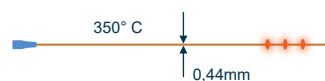

**PK1 - PEEK Tubing**

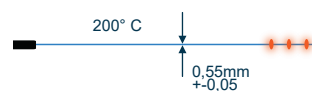

**HY - Hytrel Tubing**

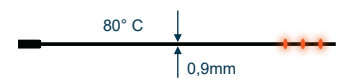

**PK2 - PEEK Tubing**

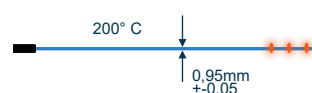

## Length/Bending Limitations

for Polyimid Fiber Type (P)

	4. Lead-in Protection					5. Sensor Capillary					
	SST	LSZ	PK1	PK2	HY	FI	SSC	SI	PK1	PK2	AC
<b>Crit. Bending Radius</b>	15mm	10mm	5mm	5mm	5mm	5mm	100mm	20mm	5mm	5mm	-
<b>Max length</b>	8m	5m	1m	3m	5m	500m	3m	2m	1m	3m	0,6m
<b>Min length</b>	0,5m	0,5m	20mm	20mm	20mm	20mm	100mm	50mm	20mm	20mm	100mm

for Uncoated Fiber Type (UHT)

	5. Sensor Capillary		
	SSC	SI	AC
<b>Crit. Bending Radius</b>	100mm	20mm	-
<b>Max length</b>	0,5m	0,5m	0,6m
<b>Min length</b>	100mm	50mm	100mm

## Ⓑ FBG Array Distance Code

in mm

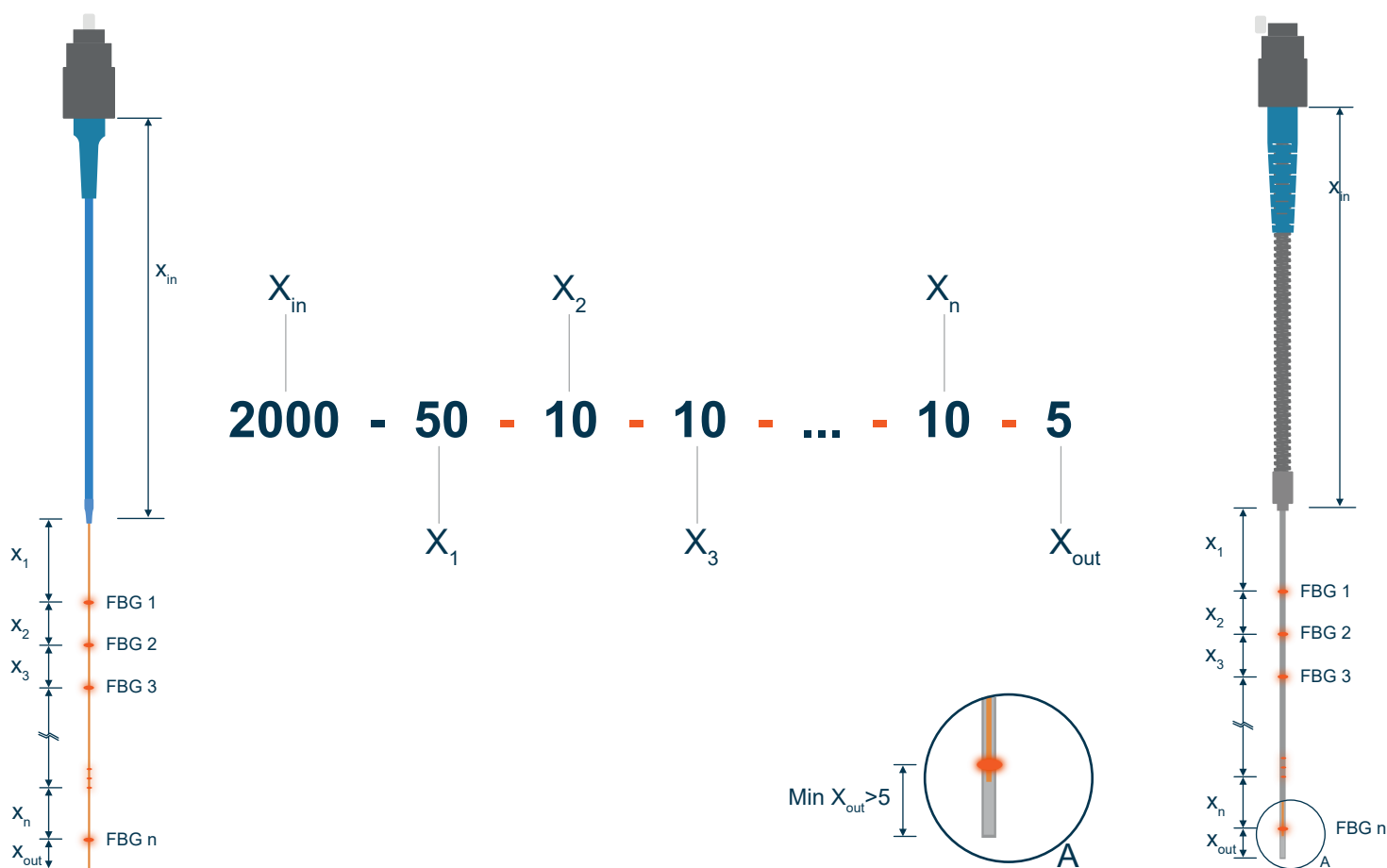

## Length Tolerances (in mm)

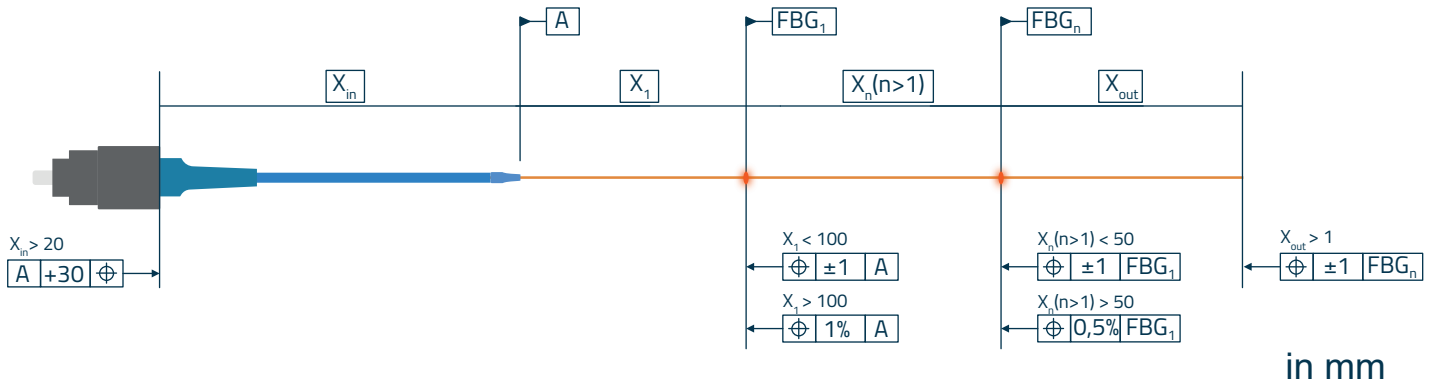

## © Custom FBG Wavelength Code

Center wavelengths (CWL) are automatically set to fit FBG Interrogator spectral ranges.  
Custom FBG wavelengths can be defined.

**Code C is not mandatory.**

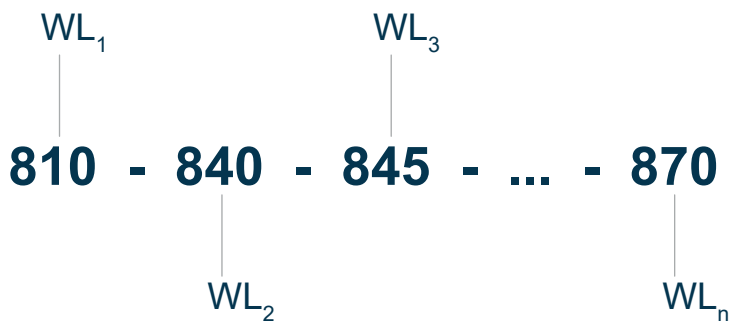

CWL Tolerance: <0,1nm

CWL Range: 808-880nm

## Exemplary Order Codes

### Suited for Strain Sensing

A: P-3-N-LSZ-SI  
B: 800-400-300-600-50

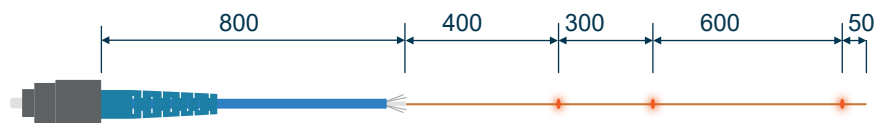

A: P-4-W-NL-FI  
B: 0-500-500-500-500-5  
C: 830-840-850-860

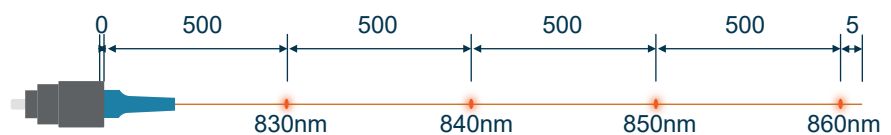

A: A-10-NEO-PK2-FI  
B: 500-50-10-10-10-10-10  
-10-10-10-10-50

